



## Membran-Luftpumpen HP



Technische Daten:				
	HP20	HP40	HP60	HP80
Art.Nr.	E0241020	E0241040	E0241060	E0241080
elektr. Anschluss:	230V/50Hz-einphasig			
mittl. Betriebsdruck:	9.8 kPa = 1 mH <sub>2</sub> O	12.8 kPa = 1.3 mH <sub>2</sub> O	14.7 kPa = 1.5 mH <sub>2</sub> O	14.7 kPa = 1.5 mH <sub>2</sub> O
Luftleistung bei mittlerem Betriebsdruck	18 l/min	40 l/min	60 l/min	80 l/min
Betriebsbereich l/min:	~5-20	~5-52	~10-76	~10-105
Betriebsbereich mH <sub>2</sub> O:	0.5 - 2.0	0.5 - 2.2	0.5 - 2.4	0.5 - 2.8
Aufnahmeleistung:	17 W	38 W	51 W	71 W
Geräuschpegel:	31 dBA	32 dBA	35 dBA	36 dBA
Gewicht:	3.2 kg	5.7 kg	7.0 kg	7.0 kg

Technische Daten:				
	HP100	HP120	HP150	HP200
Art.Nr.	E0241100	E0241120	E0241150	E0241200
elektr. Anschluss:	230V/50Hz-einphasig			
mittl. Betriebsdruck:	17.7 kPa = 1.8 mH <sub>2</sub> O	17.7 kPa = 1.8 mH <sub>2</sub> O	20.0 kPa = 2.0 mH <sub>2</sub> O	20.0 kPa = 2.0 mH <sub>2</sub> O
Luftleistung bei mittlerem Betriebsdruck	100 l/min	120 l/min	150 l/min	200 l/min
Betriebsbereich l/min:	~15-140	~20-160	~25-225	~30-280
Betriebsbereich mH <sub>2</sub> O:	0.5 - 3.2	0.5 - 3.4	0.5 - 3.4	0.5 - 3.6
Aufnahmeleistung:	95 W	115 W	125 W	210 W
Geräuschpegel:	38 dBA	40 dBA	45 dBA	46 dBA
Gewicht:	8.5 kg	8.5 kg	9.0 kg	9.0 kg



— 50Hz — 60Hz — Rated pressure — Pressure range for use

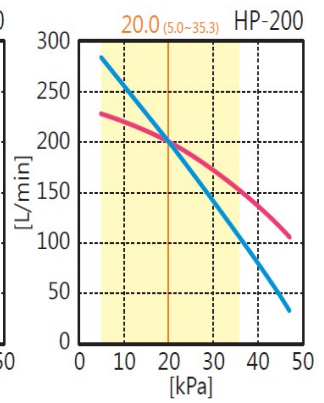
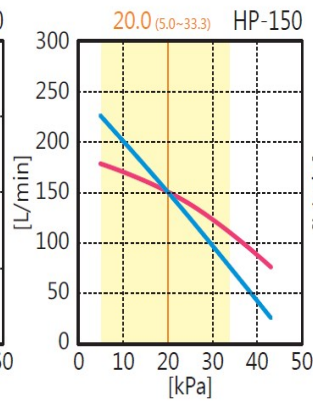
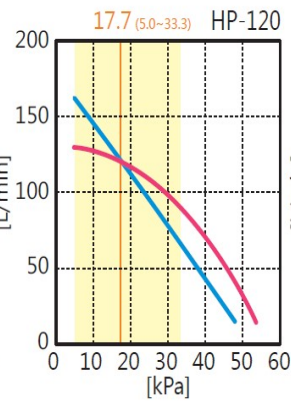
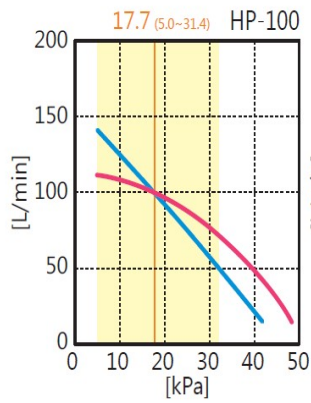
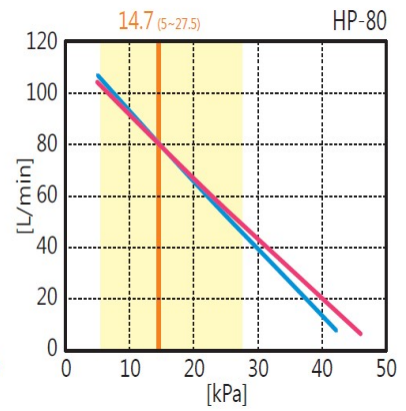
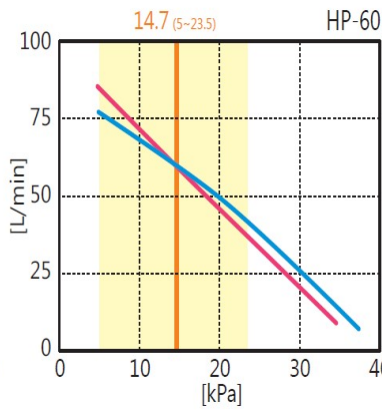
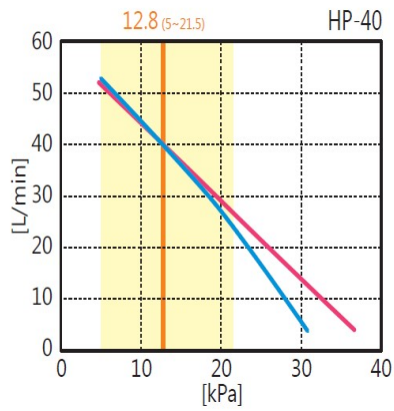
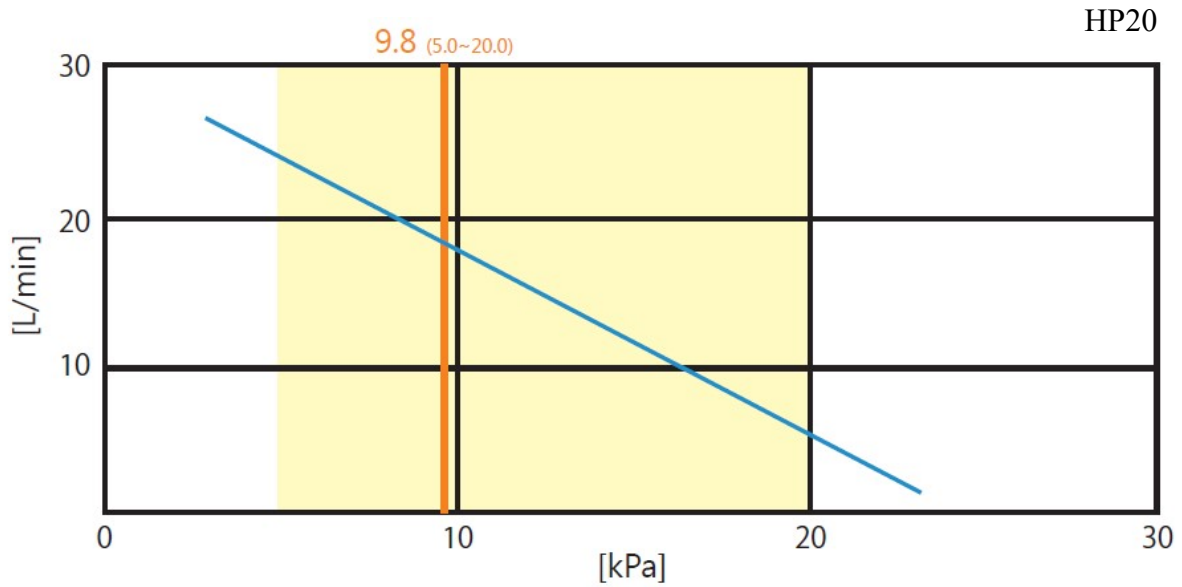

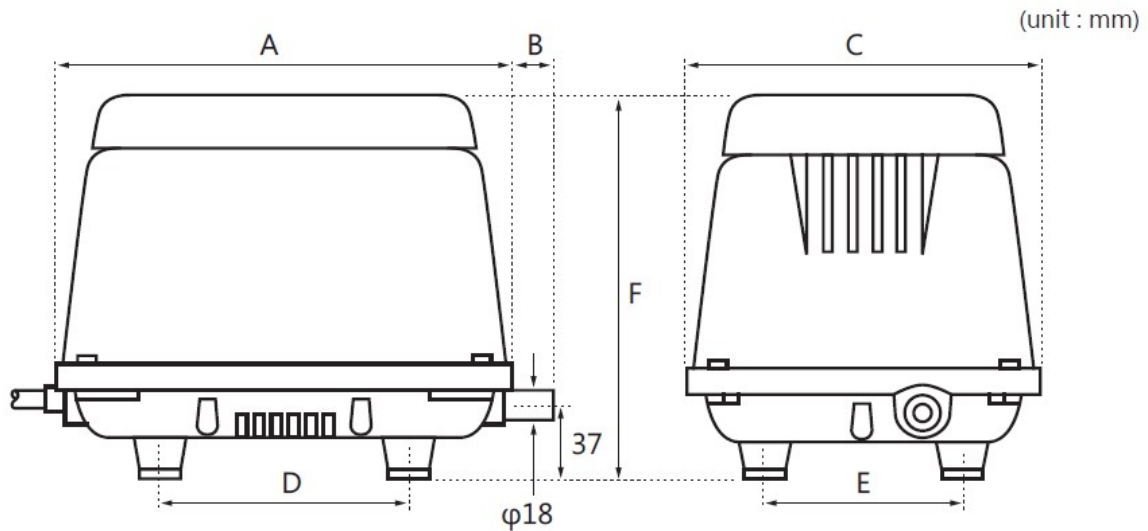

### Technische Daten:

	HP20	HP40	HP60	HP80	HP100	HP120	HP150	HP200
<b>A</b>	182	208	235	235	256	256	256	256
<b>B</b>	21	20	21	21	20	20	20	20
<b>C</b>	138	171	180	180	200	200	200	200
<b>D</b>	92	120	130	130	140	140	140	140
<b>E</b>	78	90	100	100	110	110	110	110
<b>F</b>	170	190	196	196	222	222	222	222
<b>Ø (*)</b>	18	18	18	18	18	18	18	18
<b>(*)</b>	Außendurchmesser Ausgang Ø 18 mm							

Hersteller: Techno Takatsuki CO., LTD. / Japan